

Installation Instructions

1. Install the three brackets into unit as shown in ILL. 1.
2. Brackets are preassembled to accept 1" filters. Reference Table 1 to configure for 2" filters.
3. Slide filters into place.

CONTENTS INCLUDED	QTY.
Left Bracket	1
Bottom Bracket	1
Right Bracket	1
13-3/8" x 23-3/8" x 3/4" Filter	2
#10 x 1/2 Sheet Metal Screw	7

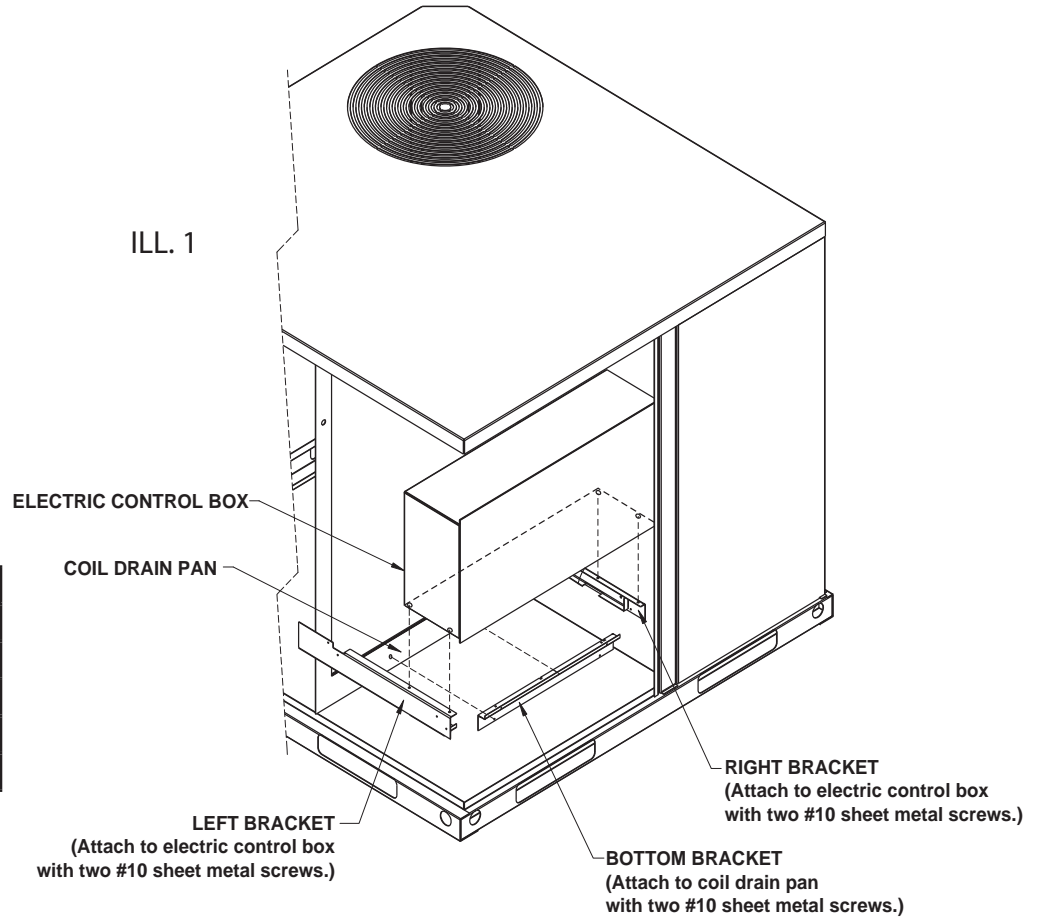
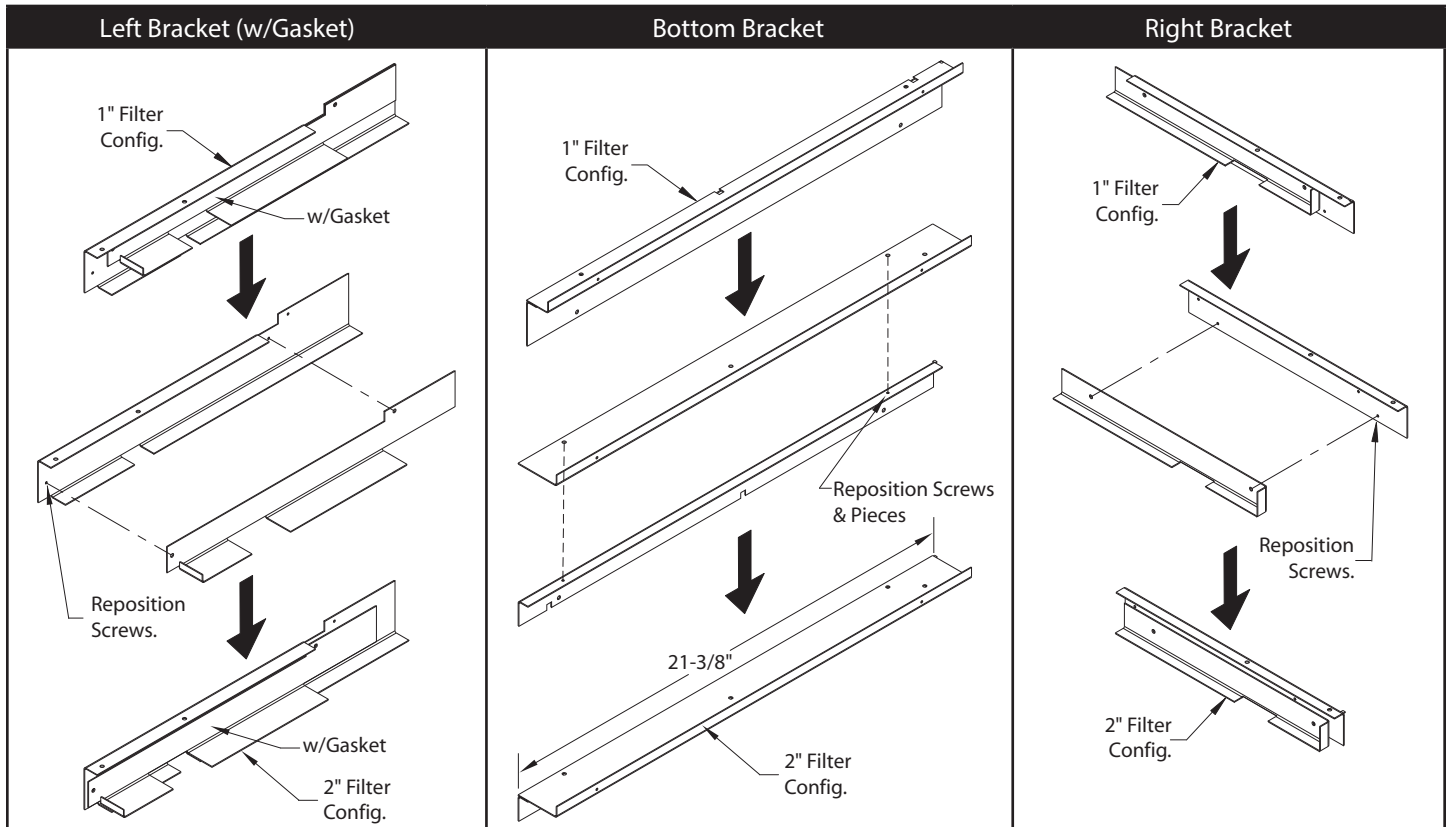

TABLE 1 - Configure for 2" Filter



3847 Wabash Drive
 Mira Loma, CA 91752

Ph: (951) 685-1101 Fax: (619) 872-9799

Installation Instructions

1. Remove mixed air compartment access panel as shown in illustration to the right.



2. Locate electrical box and evaporator coil.

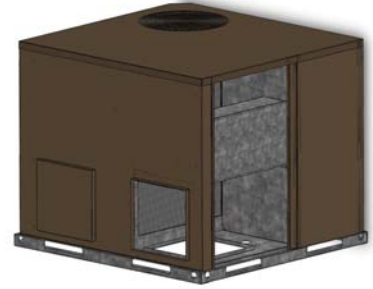

3. Install bottom bracket as shown using provided TEK screws.

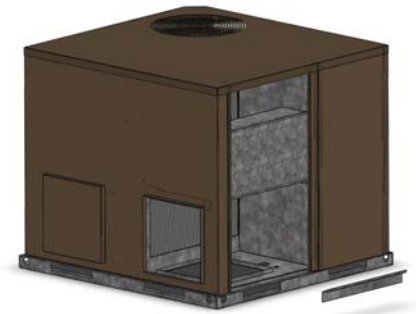

4. Verify bottom bracket is properly installed per illustration to the right.

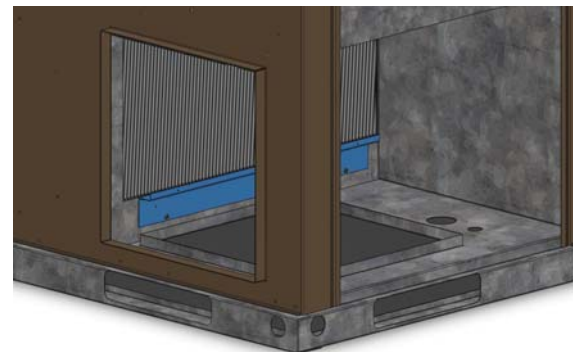

Left Bracket

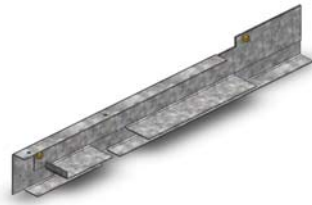

Right Bracket



5. Install Right and Left brackets to the right and left bottom of the electrical box as shown.

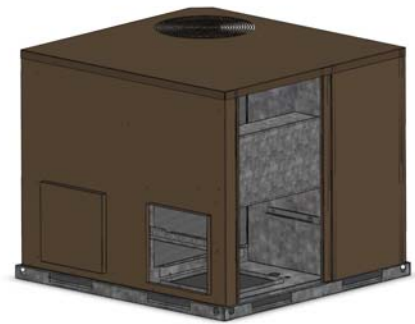
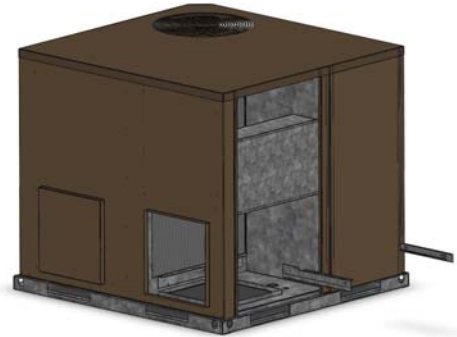

6. Verify both brackets are properly installed per illustration to the right.



7. Install vertical filter against evaporator coil as shown.

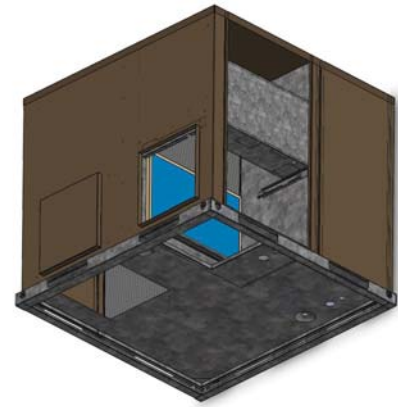

8. Verify filter installation appears as it does in the illustration to the right.

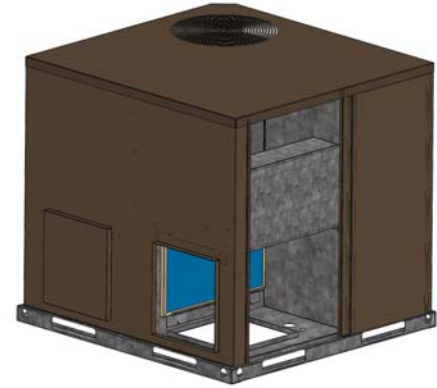

9. Install horizontal filter underneath the electrical box as shown.

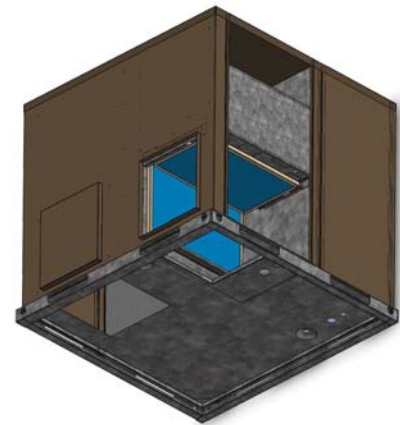

10. Verify both filters are installed as shown in the illustration to the right.

