



INSTALLATION INSTRUCTIONS
ECODPRD3715 Series Vertical Economizer
for
York Predator 3 -12½ Ton Units

Before Starting Installation

Warning

Shut power to unit prior to any work being done. Personal injury or death could result.

Only qualified HVAC service personnel should install, troubleshoot, repair or service HVAC and related HVAC equipment.

Important

If supplied with power exhaust option, power exhaust power (Molex) connection is located on economizer next to its power connection. Make sure to plug in power exhaust when connecting economizer power in Step 3 of instructions below.

Installation Instructions

1. Turn power off to unit being serviced or worked on.
2. Remove horizontal duct panel on side of unit and both mixed air compartment panels on end of unit. Save the unit screws for securing economizer hood to unit. (ILL. 1)
3. Remove factory Molex plug from unit prior to installing economizer. Save this plug for future use. Slide economizer into end of unit until two thirds of the way in. Plug economizer Molex Plug into unit Molex plug then slide economizer into unit flush slightly lifting the back of the economizer over embossment in unit base.

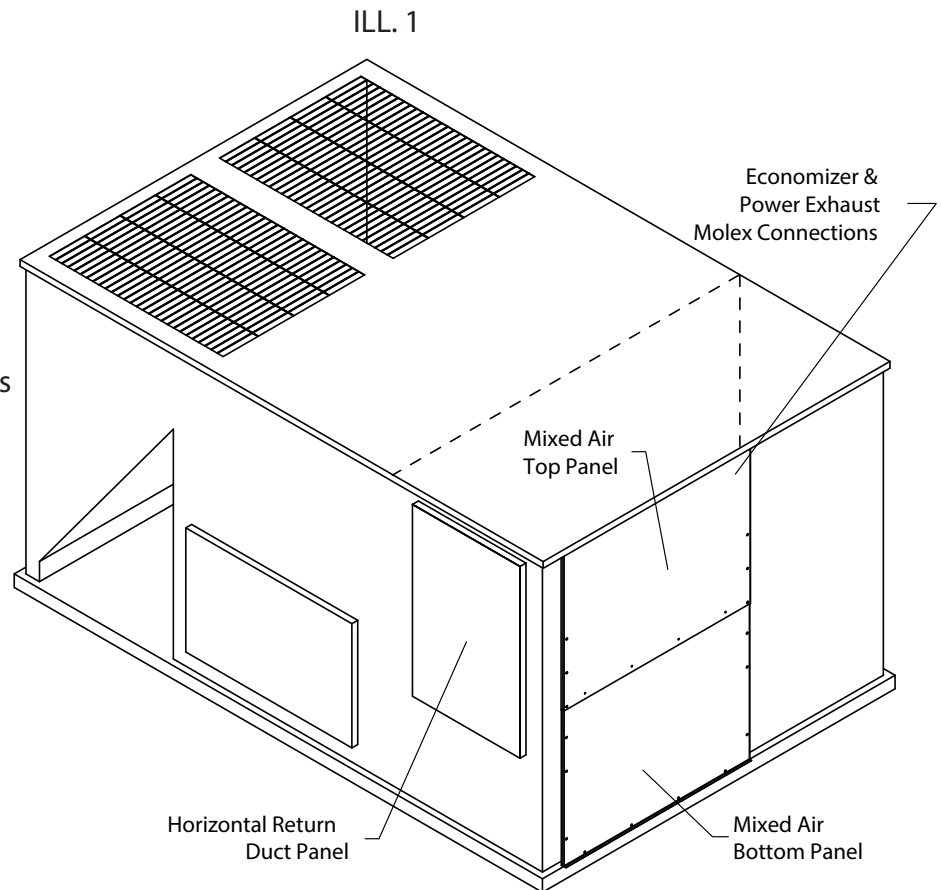

4. Locate relief hood (without filter). Install relief hood first at bottom of opening. Then attach outside air hood on top.

For large cabinet units, an additional filler panel is provided. Install this panel at top. (Please note: This panel is not used on small cabinet units). (ILL. 2)

5. Use horizontal return duct panel for access to controls. Reattach this panel when completed. The two end unit panels are no longer needed.

For specific wiring of unit with economizer, please refer to diagram on back of HVAC control panel.

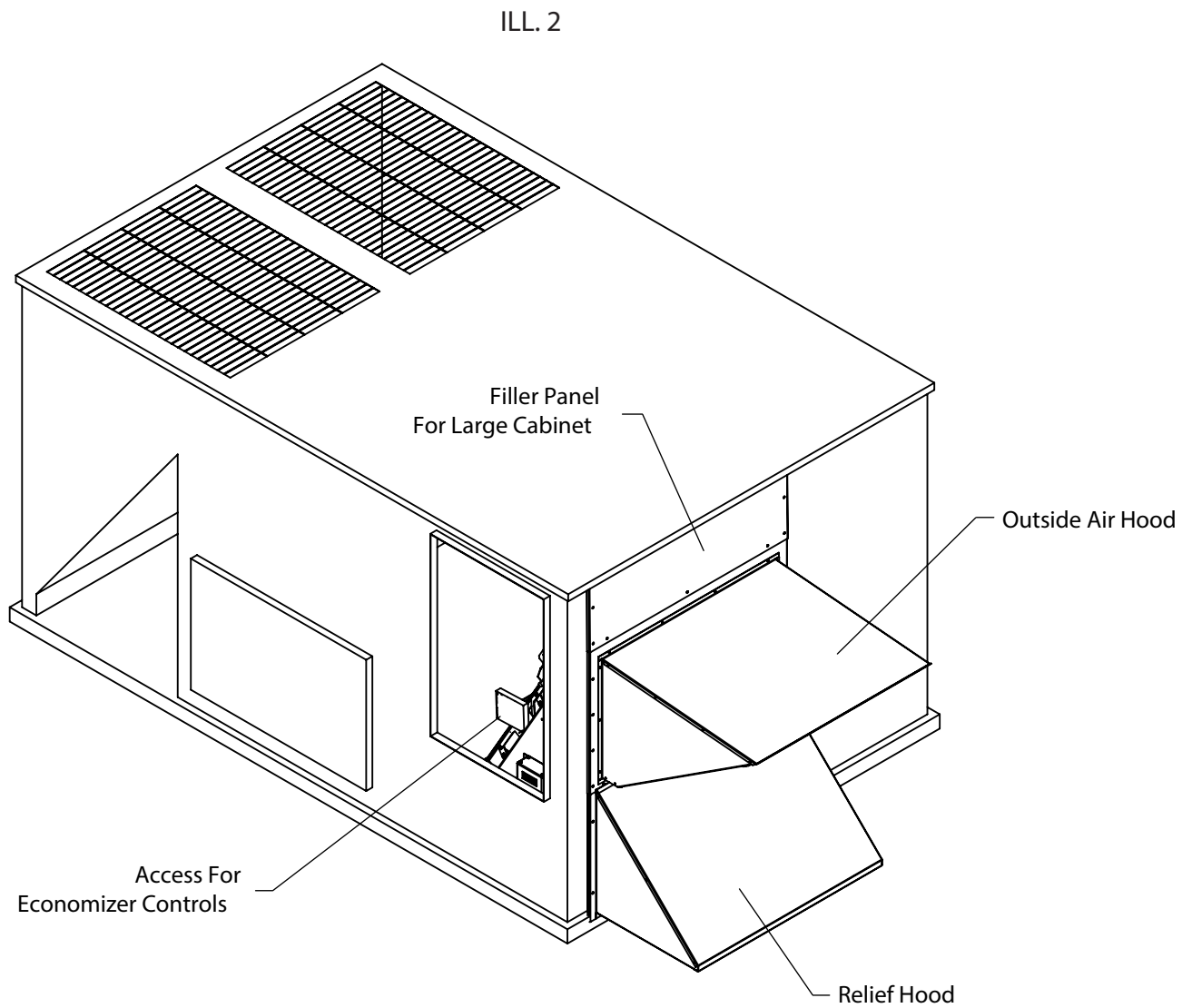

ILL. 3

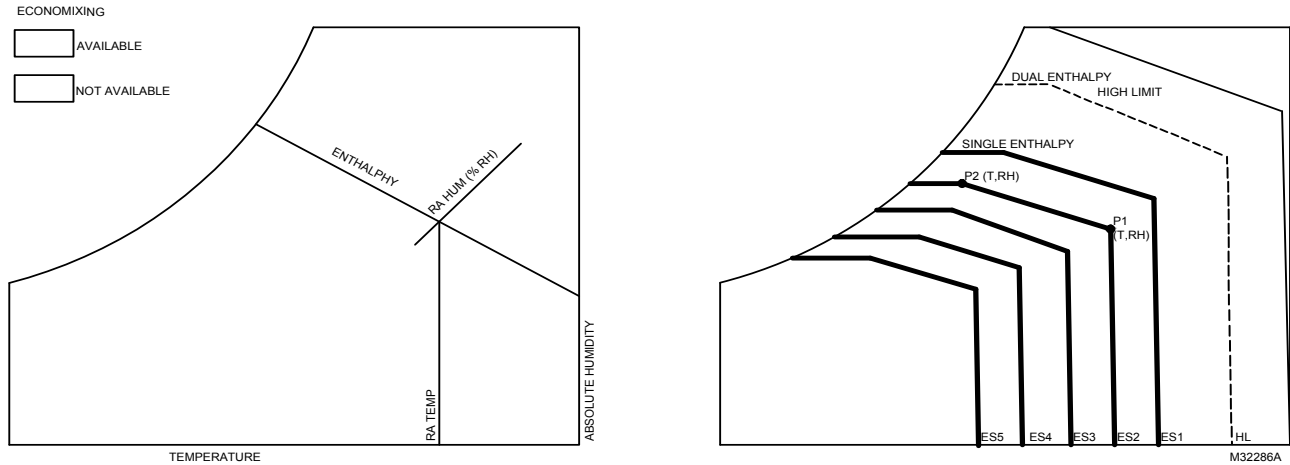

Single Enthalpy and Dual Enthalpy High Limit Curves

Enthalpy Curve	Temp. Dry- Bulb (°F)	Temp. Dewpoint (°F)	Enthalpy (btu/lb/da)	Point P1		Point P2	
				Temp. °F	Humidity %RH	Temp. °F	Humidity %RH
ES1	80.0	60.0	28.0	80.0	36.8	66.3	80.1
ES2	75.0	57.0	26.0	75.0	39.6	63.3	80.0
ES3	70.0	54.0	24.0	70.0	42.3	59.7	81.4
ES4	65.0	51.0	22.0	65.0	44.8	55.7	84.2
ES5	60.0	48.0	20.0	60.0	46.9	51.3	88.5
HL	86.0	66.0	32.4	86.0	38.9	72.4	80.3

ILL. 4
Control Wiring Diagram

YORK PREDATOR ECONOMIZER
CONTROL WIRING DIAGRAM

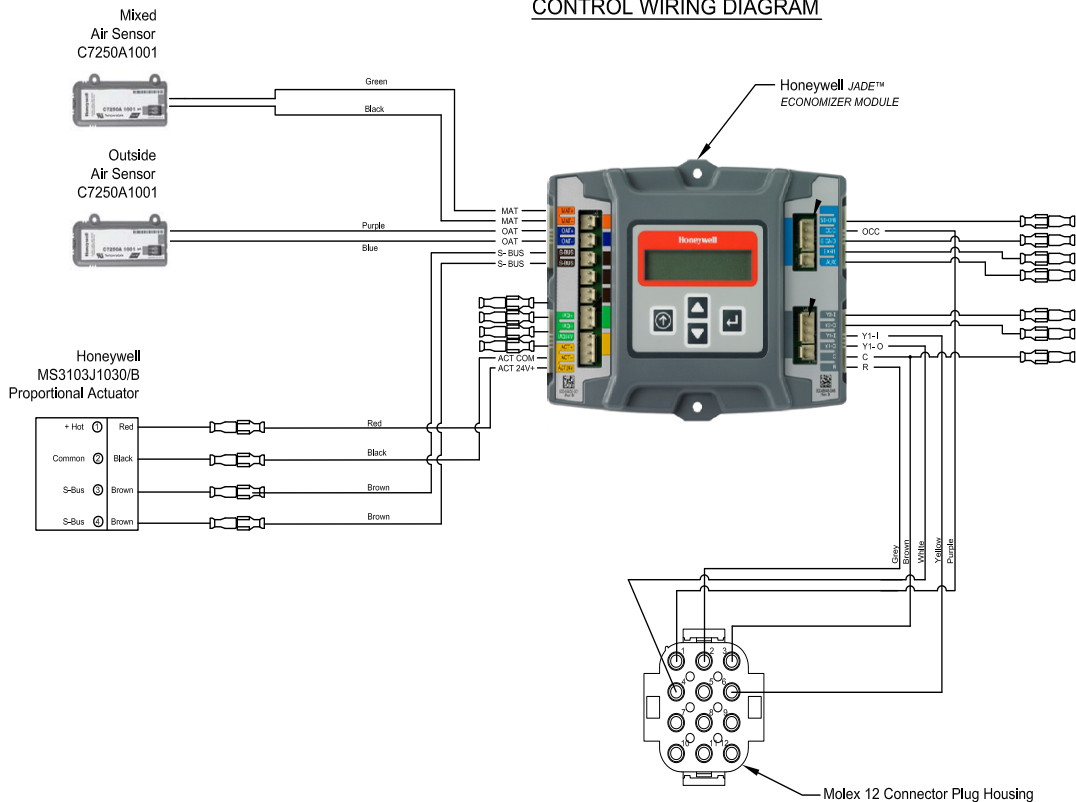

Sensor Options

- When the Enthalpy option for the OA is selected, the Honeywell sensor C7400S100 needs to be used. For factory Enthalpy option the sensor is installed and connected. (ILL. 6)
- For the Field Installation Enthalpy option, the sensor C7400S100 needs to be placed in the proper location between the OA Hood and the OA Damper from the economizer, for the next step the 2 pin Top connector needs to be removed from OAT (Blue) to S-BUS (Brown) on the Jade controller; refer to the wiring diagram. (ILL. 6)
- For the Field Installation Sensor option, use ILL. 5 and Table 1 to set the DIP switches for the desired use of the sensor.

ILL. 5
Sylk Bus sensor DIP switches

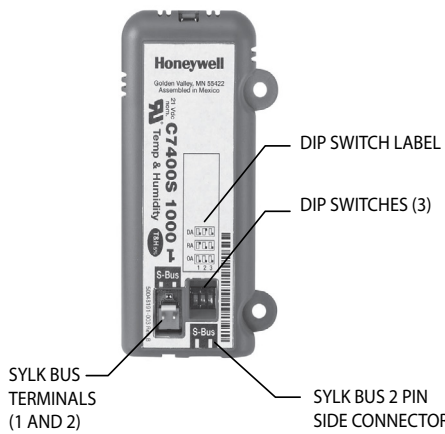
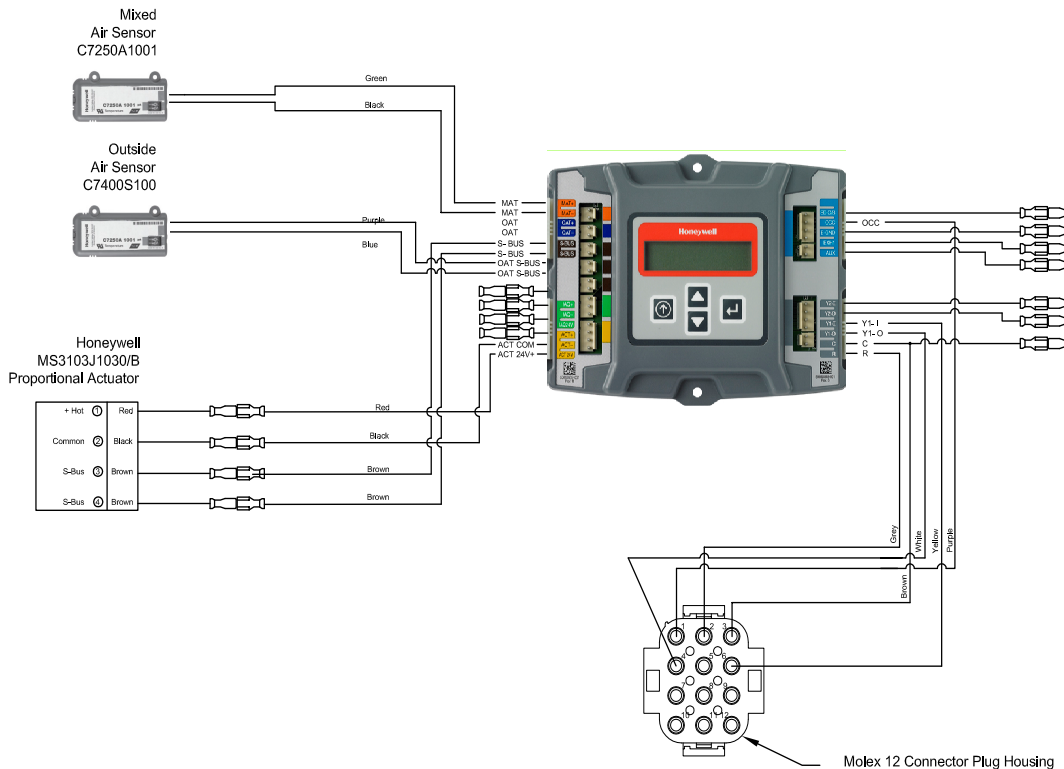

Table 1
Sylk Bus Sensor DIP Switches Settings

Use	DIP Switch Positions for Switches 1, 2, & 3		
	1	2	3
DA a	OFF	ON	OFF
RA b	ON	OFF	OFF
OA c	OFF	OFF	OFF
a DA = Discharge Air			
b RA = Return Air			
c OA = Outdoor Air			

ILL. 6
Control Wiring Diagram



INTERFACE OVERVIEW

This section describes how to use the Economizer's user interface for:

- Keypad and menu navigation
- Settings and parameter changes
- Menu structure and selection

User Interface

The user interface consists of an LCD display and a 4-button keypad on the front of the Economizer module. The LCD is a 16 character by 2 line dot matrix display.

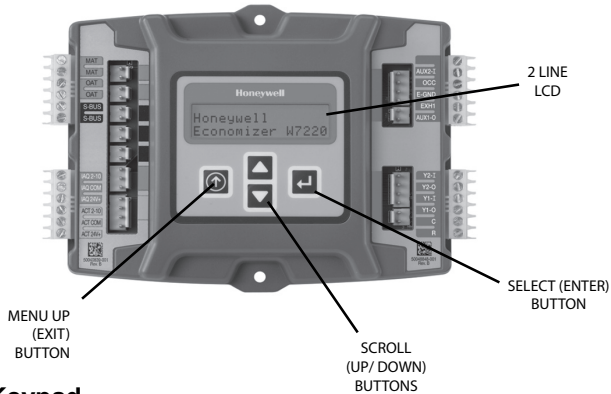

Keypad

The four navigation buttons illustrated above are used to scroll through the menus and menu items, select menu items, and to change parameter and configuration settings.

Using the Keypad with Menus

To use the keypad when working with menus:

- Press the ▲ button to move to the previous menu.
- Press the ▼ button to move to the next menu.
- Press the ↵ button (Enter) to display the first item in the currently displayed menu.
- Press the ⏪ button (Menu Up) to exit a menu's item and return to the list of menus.

Using the Keypad with Settings and Parameters

To use the keypad when working with Setpoints, System and Advanced Settings, Checkout test, and Alarms:

- Navigate to the desired menu.
- Press the ↵ button (Enter) to display the first item in the currently displayed menu.
- Use the ▲ and ▼ buttons to scroll to the desired parameter.
- Press the ↵ button (Enter) to display the value of the currently displayed item.
- Press the ▲ button to increase (change) the displayed parameter value.^a
- Press the ▼ button to decrease (change) the displayed parameter value.^a

- Press the ↵ button to accept the displayed value and store it in non-volatile RAM.
- CHANGE STORED displayed.
- Press the ⏪ button (MenuUp/Exit) to return to the previous menu.

^a When values are displayed, pressing and holding the ▲ or ▼ button causes the display to automatically increment.

Menu Structure

Table 5 on the next page illustrates the complete hierarchy menus and parameters for the JADE™ Economizer system.

The Menus in display order are:

- STATUS
- SETPOINTS
- SYSTEM SETUP
- ADVANCED SETUP
- CHECKOUT
- ALARMS

IMPORTANT

Table 5 on the next page illustrates the complete hierarchy. Your menu parameters will be different depending on your configuration.

For example if you do not have a DVC (CO₂) sensor, then none of the DCV parameters appear and only MIN POS will display. If you have a CO₂ sensor, the DCV MIN and DCV MAX will appear AND if you have 2 speed fan DCV MIN (high and low speed) and DCV MAX (high and low speed will appear).

SETUP AND CONFIGURATION

Before being placed into service, the JADE™ Economizer module must be setup and configured for the installed system.

IMPORTANT

During setup, the Economizer module is live at all times.

The setup process uses a hierarchical menu structure that is easy to use. You press the ▲ and ▼ arrow buttons to move forward and backward through the menus and press the ⏪ button to select and confirm setup item changes.

Time-out and Screensaver

When no buttons have been pressed for 10 minutes, the LCD displays a screen saver, which cycles through the Status items. Each status items displays in turn and cycles to the next item after 5 seconds.

CHECKOUT

Inspect all wiring connections at the Economizer module's terminals, and verify compliance with the installation wiring diagrams.

For checkout, review the Status of each configured parameter and perform the Checkout test.

Note: See “Interface Overview” on the previous page for information about menu navigation and use of the keypad.

WARNING

Electrical Shock Hazard.

Can cause severe injury, death or property damage.

Disconnect power supply before beginning wiring or making wiring connections, to prevent electrical shock or equipment damage.

If any wiring changes are required, first be sure to remove power from the Economizer module before starting work. Pay particular attention to verifying the power connection (24 Vac).

Power Up

After the module is mounted and wired, apply power.

Initial Menu Display

On initial startup, **Honeywell** displays on the first line and **Economizer W7220** on the second line. After a brief pause, the revision of the software appears on the first line and the second line will be blank.

Power Loss (Outage or Blowout)

All setpoints and advanced settings are restored^a after any power loss or interruption.

TROUBLESHOOTING

Alarms

The Economizer module provides alarm messages that display on the 2-line LCD.

NOTE: Upon power up, the module waits 60 minutes before checking for alarms. This allows time for all the configured devices (e.g. sensors, actuator) to become operational. The exception is the MA sensor which will alarm immediately.

If one or more alarms are present and there has been no keypad activity for at least 5 minutes, the Alarms menu displays and cycles through the active alarms.

You can also navigate to the Alarms menu at any time.

^a All settings are stored in non-volatile flash memory.

Status

Use the status menu (see table 2) to check the parameter values for the various devices and sensors configured.

Note: See “Interface Overview” on the previous page for information about menu navigation and use of the keypad.

Checkout Test

Use the Checkout menu (Table 2) to test the damper operation and any configured outputs. Only items that are configured are shown in the Checkout menu.

Note: See “Interface Overview” on the previous page for information about menu navigation and use of the keypad.

To perform a Checkout test:

1. Scroll to the desired test in the Checkout menu using the ▲ and ▼ buttons.
2. Press the ↵ button to select the item.
3. RUN? Appears on the display.
4. Press the ↵ button to start the test.
5. The unit pauses and then displays IN PROGRESS.
6. When all parameters have been tested, press the Ⓜ button (Menu up) to end the test (e.g. turn off the relay).

The Checkout test can all be performed at the time of installation or any time during the operation of the system as a test that the system is operable.

CAUTION

Equipment damage may result.

Be sure to allow enough time for compressor start up and shutdown between checkout tests so that you do not short-cycle the compressors.

Clearing Alarms

Once the alarm has been identified and the cause has been removed (e.g. replaced faulty sensor), the alarm can be cleared from the display.

To clear an alarm, perform the following:

1. Navigate to the desired alarm.
2. Press the ↵ button.
3. ERASE? displays.
4. Press the ↵ button.
5. ALARM ERASED displays.
6. Press the Ⓜ button (MenuUp/ Exit) to complete action and return to the previous menu.

NOTE: If an alarm still exists after you clear it, it re-displays within 5 seconds.

Table 2 Structure Menu

Menu	Parameter	Parameter Default Value	Parameter Range and Increment	Notes	
SETPOINTS	MIN POS	2.8V	2 to 10 Vdc	Displays ONLY if a CO2 sensor is NOT connected.	
				With 2- speed fan units MIN POS L (low speed fan) and MIN POS H (high speed fan) setting are required. Default for MIN POS L is 3.2V and MIN POS H is 2.8V.	
	DCV SET	1100ppm	500 to 2000 pmm Increment by 100	Displays ONLY if a CO2 sensor is connected. Set point for Demand Control Ventilation of space. Above the set point, the OA dampers will modulate open to bring in additional OA to maintain a space ppm level below the set point.	
	VENTMAX	2.8 V	2 to 10 Vdc	Displays only if a CO2 sensor is connected. Used for Vbz (ventilation max cfm) setpoint. VENTMAX is the same setting as MIN POS would be if you did not have the CO2 sensor.	
				100 to 9990 cfm increment by 10	If OA, MA RA and CO2 sensors are connected and DCV CAL ENABLE is set to AUTO mode, the OA dampers are controlled by CFM and displays from 100 to 9990 cfm.
				2 to 10 Vdc	With 2-speed fan units VENTMAX L (low speed fan) and VENTMAX H (high speed fan) settings are required. Default for VENTMAX L is 3.2V and VENTMAX H is 2.8V.
	VENTMIN	2.25 V	2 to 10 Vdc	Displays only if CO2 sensor is connected. Used for Va (ventilation min cfm) setpoint. This is the ventilation requirement for less than maximum occupancy of the space.	
				100 to 9990 cfm increment by 10	If OA, MA RA and CO2 sensors are connected and DCV CAL ENABLED is set to AUTO mode, the OA dampers are controlled by CFM and displays from 100 to 9990 cfm.
				2 to 10 Vdc	With 2-speed fan units VENTMIN L (low speed fan) and VENTMIN H (high speed fan) settings are required. Default for VENTMIN L is 2.5V and VENTMIN H is 2.25V.
	EXH1 SET	50%	0 to 100%: Increment by 1	Setpoint for OA damper position when exhaust fan 1 is powered by the economizer. With 2-speed fan units Exh1 L (low speed fan) and Exh1 H (high speed fan) setting are required. Default for Exh1 L is 65% and Exh1 H is 50%.	
MAT SET	53F	38 to 70 F; Increment by 1	The economizer will modulate the OA damper to maintain the mixed air temperature at the setpoint.		
DRYBULB SET	63F	48 to 80 F; Increment by 1	Dry bulb setpoint will only appear if using dry bulb change over. Setpoint determines where the economizer will assume outdoor air temperature is good for free cooling; e.g.; at 63F setpoint un it will economize at 62F below and not economize at 64F and above. There is a 2F deadband.		
ENTH CURVE	ES3	ES1, ES2, ES3, ES4, or ES5	ES Curve will only appear if using enthalpy change over. Enthalpy boundary "curves" for economizing using single enthalpy. See page 3 for description of enthalpy curves.		
SYSTEM SETUP	INSTALL	01/01/11		Display order = MM/DD/YY Setting order = DD, MM, then YY.	
	EQUIPMENT	CONV	CONV HP	CONV = conventional HP O/B = Enables Heat Pump mode. Use AUX2 I for Heat Pump input from thermostat or controller.	
	AUX2 IN	n/a	Shutdown (SD) Heat (W1) HP (O) HP (B)	In CONV mode: SD = Enables configuration of shutdown (default); W = Informs controller that system is in heating mode. NOTE: if using 2-speed fan mode, you must program CONV mode for W.	

Table 2 Structure Menu (cont.)

Menu	Parameter	Parameter Default Value	Parameter Range and Increment	Notes
SYSTEM SETUP (cont.)	AUX2 IN (cont.)	n/a	Shutdown (SD) Heat (W1) HP (O) HP (B)	Shutdown is not available in the two-speed fan mode. In HP O/B mode: HP (O) = energize heat pump on Cool (default); HP (B) = energize heat pump on Heat.
	FAN CFM	5000cfm	100 to 50000 cfm; Increment by 100	This is the capacity of the RTU. The value is found on the label from the RTU manufacturer. The cfm of the fan is only used with DCV CAL ENABLE AOU
	AUX1 OUT	NONE	NONE ERV EXH2 SYS	SYS = use output as an alarm signal.
	OCC	INPUT	INPUT or ALWAYS	When using a setback thermostat with occupancy out (24 Vac), the 24 Vac is input "INPUT" to the OCC terminal. If no occupancy output from the thermostat then change program to "ALWAYS" OR add a jumper from terminal R to OCC terminal.
CHECKOUT	DAMPER MINIMUM POSITION	n/a	n/a	The checkout for the damper minimum positions is based on the system.
	DAMPER OPEN	n/a	n/a	Positions damper to the full open position. Exhaust fan contacts enable during the DAMPER OPEN test. Make sure you pause in this mode to allow for exhaust contacts to energize due to the delay in the system.
	DAMPER CLOSE	n/a	n/a	Positions damper to the fully closed position.
	CONNECT Y1-O	n/a	n/a	Closes the Y1-0 relay (Y1-0). See CAUTION on page 6.
	CONNECT Y2-O	n/a	n/a	Closes the Y2-0 relay (Y2-0). See CAUTION on page 6.
	CONNECT AUX1-O	n/a	n/a	Energizes the AUX1-0 output. If AUX1-0 setting is: <ul style="list-style-type: none"> • NONE- no action taken • ERV- 24 Vac out. Turns on or signals an ERV that the conditions are not good for economizing but are good for ERV operation. • SYS- 24 Vac out. Issues a system alarm.
	CONNECT EXH1	n/a	n/a	Closes the power exhaust fan 1 relay (EXH1).
ADVANCED SETUP	CO2 ZERO	0ppm	0 to 500 ppm; Increment by 10	CO2 ppm level to match CO2 sensor start level.
	CO2 SPAN	2000ppm	1000 to 3000ppm; Increment by 50	CO2 ppm span to match CO2 sensor.
ALARMS (#)				Alarms display only when they are active. The menu title "ALARMS (#)" includes the number of active alarms in parenthesis (). When using SYLK bus sensors, "SYLK" will appear on the screen, and when using 20k OA temperature sensors, "SENS T" will appear on the screen.
	MA T SENS ERR	n/a	n/a	Mixed air sensor has failed or become disconnected- check wiring then replace sensor if the alarm continues.
	CO2 SENS ERR	n/a	n/a	CO2 sensor has failed, gone out of range or become disconnected- check wiring then replace sensor if the alarm continues.
	OA SYLK T ERR	n/a	n/a	Outdoor air enthalpy sensor has failed or become disconnected- check wiring then replace sensor if the alarm continues.
	OA SYLK H ERR	n/a	n/a	

Table 2 Structure Menu (cont.)

Menu	Parameter	Parameter Default Value	Parameter Range and Increment	Notes
ALARMS (cont.)	RA SYLK T ERR	n/a	n/a	Return air enthalpy sensor has failed or become disconnected- check wiring then replace sensor if the alarm continues.
	RA SYLK H ERR	n/a	n/a	
	DA SYLK T ERR	n/a	n/a	Discharge air sensor has failed or become disconnected- check wiring then replace sensor if the alarm continues.
	OA SENS T ERR	n/a	n/a	Outdoor air temperature sensor has failed or become disconnected- check wiring then replace sensor if the alarm continues.
	ACT ERROR	n/a	n/a	Actuator has failed or become disconnected- check for stall, over voltage, under voltage and actuator count. Replace actuator if damper is moveable and supply voltage is between 21.6V and 26.4V. Check actuator count on STATUS menu.
	FREEZE ALARM	n/a	n/a	Check if outdoor temperature is below the LOW Temp Lockout on the setpoint menu. Check if Mixed air temperature on STATUS menu is below the Lo Setpoint on Advanced setup menu. When conditions are back in normal range then the alarm will go away.
	SHUTDOWN ACTIVE	n/a	n/a	AUX2 IN is programmed for SHUTDOWN and 24V has been applied to AUX2 IN terminal.
	DMP CAL RUNNING	n/a	n/a	If DCV Auto enable has been programmed, when the Jade is completing a calibration on the dampers, this alarm will display. Wait until the calibration is completed and the alarm will go away. Must have OA, MA RA sensors for DCV calibration: set up is in the Advanced setup menu.
	DA SENS ALM	n/a	n/a	Discharge air temperature is out of the range set in the ADVANCED SETUP Menu. Check the temperature of the discharge air.

CO2 Sensor Wiring

When using the C7232 Honeywell CO2 sensor the black and brown common wires are internally connected and only one is connected to "IAQ COM" on the Jade to power the CO2 sensor OR make sure the ground for the power supplies are common. See wiring diagram to the right for the C7232 and C7632 wiring diagrams.

NOTE: When using the C7632 (or any 0-10 Vdc CO2 sensors) with the Jade you will need to set the CO2ZERO to 400 ppm and the CO2SPAN to 1600 ppm in the ADVANCED SETUP menu.

ILL. 7
Jade controller application

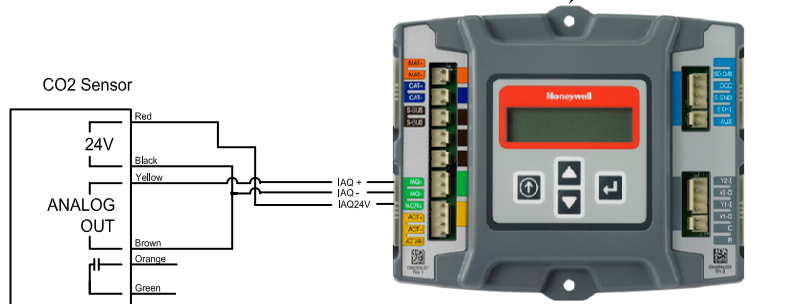

ILL. 8

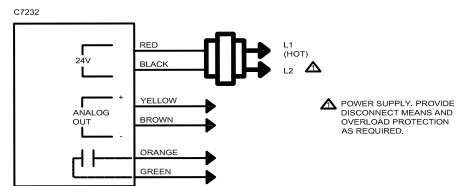

Fig. a Wiring for C7232

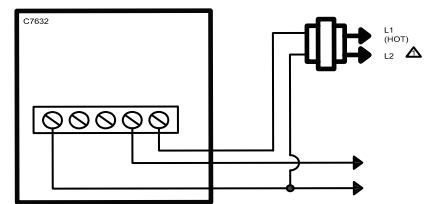

Fig. b Wiring for C7632

AIR ECONOMIZER CONTROLS ACCEPTANCE

CEC-NRCA-MCH-05-A (Revised 06/14)

CALIFORNIA ENERGY COMMISSION



CERTIFICATE OF ACCEPTANCE		NRCA-MCH-05-A
Air Economizer Controls Acceptance		(Page 1 of 3)
Project Name:	Enforcement Agency:	Permit Number:
Project Address:	City:	Zip Code:
System Name or Identification/Tag:	System Location or Area Served:	
Note: Submit one Certificate of Acceptance for each system that must demonstrate compliance.		Enforcement Agency Use: Checked by/Date

A. Construction Inspection
<p>1. Supporting documentation needed to perform test includes:</p> <ol style="list-style-type: none"> 2013 Building Energy Efficiency Standards Nonresidential Compliance Manual (NA7.5.4 Air Economizer Controls Acceptance At - Glance). 2013 Building Energy Efficiency Standards.
<p>2. Instrumentation to perform test includes:</p> <ol style="list-style-type: none"> Hand-held temperature probe Calibration Date: _____ (must be within last year) Device capable of calculating enthalpy Calibration Date: _____ (must be within last year) 1.2 k Ohm Resistor (when specified by the manufacturer)
<p>3. Installation: (all of the following boxes should be checked)</p> <p><input type="checkbox"/> Economizer high limit shutoff control complies with Table 140.4-B found in the 2013 Building Energy Efficiency Standards Section 140.4(e)3.</p> <p><input type="checkbox"/> Economizer reliability features are present per 2013 Building Energy Efficiency Standards Section 140.4(e)4:</p> <ol style="list-style-type: none"> 5-year manufacturer warranty of economizer assembly Provide a product specification sheet proving capability of at least 60,000 actuations Provide a product specification sheet proving compliance with AMCA Standard 500 damper leakage at 10 cfm/sf at 1.0 in w.g. A product specification sheet showing the manufacturer's results after following the testing procedures of AMCA Standard 500 or AMCA certification by a third party under AMCA Publication 511 can be used to satisfy this requirement (Class 1A, 1, and 2 are acceptable). If the high limit setpoint is fixed dry-bulb or fixed enthalpy + fixed dry-bulb then the control shall have an adjustable setpoint Outdoor air, return air, mixed air, and supply air sensors shall be calibrated as follows: <ol style="list-style-type: none"> Drybulb and wetbulb temperatures accurate to $\pm 2^{\circ}\text{F}$ over the range of 40°F to 80°F Enthalpy accurate to ± 3 Btu/lb over the range of 20 Btu/lb to 36 Btu/lb Relative humidity (RH) accurate to $\pm 5\%$ over the range of 20% to 80% RH Check that the sensor performance curve(s) is provided by the factory and sensor output values measured during sensor calibration are plotted on the performance curve(s) Sensors used for high limit control shall be located to prevent false readings, including but not limited to being properly shielded from direct sunlight. <p><input type="checkbox"/> Unitary systems with an economizer have control systems, including two-stage or electronic thermostats, that cycle compressors off when economizers can provide partial cooling</p> <p><input type="checkbox"/> System has return fan speed control, relief dampers, or dedicated relief fans to prevent building over pressurization in full economizer mode.</p> <p><input type="checkbox"/> For systems with DDC controls, sensor used for economizer lockout has been factory or field calibrated.</p> <p><input type="checkbox"/> For systems with non-DDC controls, manufacturer's startup and testing procedures have been applied.</p>

AIR ECONOMIZER CONTROLS ACCEPTANCE



CERTIFICATE OF ACCEPTANCE		NRCA-MCH-05-A
Air Economizer Controls Acceptance		(Page 2 of 3)
Project Name:	Enforcement Agency:	Permit Number:
Project Address:	City:	Zip Code:
System Name or Identification/Tag:	System Location or Area Served:	

B. Functional Testing	Results
Step 1: Disable demand control ventilation systems (if applicable)	
Step 2: Enable the economizer and simulate a cooling demand large enough to drive the economizer fully open. Verify the following:	
a. Economizer damper modulates 100% open.	Y / N
b. Return air damper modulates 100% closed.	Y / N
c. For systems that meet the criteria of 2013 Building Energy Efficiency Standards Section 140.4(e)1, verify that the economizer remains 100% open with the use of mechanical cooling. This occurs when the cooling demand can no longer be met by the economizer alone.	Y / N
d. All applicable fans and dampers operate as intended to maintain building pressure.	Y / N
e. The unit heating is disabled (if applicable).	Y / N / NA
Step 3: Disable the economizer and simulate a cooling demand. Verify the following:	
a. Economizer damper closes to its minimum position.	Y / N
b. All applicable fans and dampers operate as intended to maintain building pressure.	Y / N
c. The unit heating is disabled (if applicable).	Y / N / NA
Step 4: If the unit is equipped with heating, simulate a heating demand and enable the economizer. Verify the following:	
a. Economizer damper closes to its minimum position.	Y / N / NA
b. Return air damper opens.	Y / N / NA
Step 5: Turn off the unit and verify the following:	
a. Economizer damper closes completely.	Y / N
Step 6: System returned to initial operating conditions	Y / N

C. Testing Results	PASS / FAIL
Step 2: Simulate cooling load and enable the economizer (all answers are Y).	
Step 3: Simulate cooling load and disable the economizer (all answers are Y).	
Step 4: Simulate heating demand and enable the economizer (all answers are Y).	
Step 5: Turn off the unit (all answers are Y).	

D.	Evaluation :	
<input type="checkbox"/> PASS: All Construction Inspection responses are complete and all Testing Results responses are "Pass"		

Notes:

AIR ECONOMIZER CONTROLS ACCEPTANCE

CEC-NRCA-MCH-05-A (Revised 06/14)

CALIFORNIA ENERGY COMMISSION



CERTIFICATE OF ACCEPTANCE		NRCA-MCH-05-A
Air Economizer Controls Acceptance		(Page 3 of 3)
Project Name:	Enforcement Agency:	Permit Number:
Project Address:	City:	Zip Code:
System Name or Identification/Tag:	System Location or Area Served:	

DOCUMENTATION AUTHOR'S DECLARATION STATEMENT	
1. I certify that this Certificate of Acceptance documentation is accurate and complete.	
Documentation Author Name:	Documentation Author Signature:
Documentation Author Company Name:	Date Signed:
Address:	ATT Certification Identification (if applicable):
City/State/Zip:	Phone:

FIELD TECHNICIAN'S DECLARATION STATEMENT	
I certify the following under penalty of perjury, under the laws of the State of California:	
<ol style="list-style-type: none"> The information provided on this Certificate of Acceptance is true and correct. I am the person who performed the acceptance verification reported on this Certificate of Acceptance (Field Technician). The construction or installation identified on this Certificate of Acceptance complies with the applicable acceptance requirements indicated in the plans and specifications approved by the enforcement agency, and conforms to the applicable acceptance requirements and procedures specified in Reference Nonresidential Appendix NA7. I have confirmed that the Certificate(s) of Installation for the construction or installation identified on this Certificate of Acceptance has been completed and signed by the responsible builder/installer and has been posted or made available with the building permit(s) issued for the building. 	
Field Technician Name:	Field Technician Signature:
Field Technician Company Name:	Position with Company (Title):
Address:	ATT Certification Identification (if applicable):
City/State/Zip:	Phone:
	Date Signed:

RESPONSIBLE PERSON'S DECLARATION STATEMENT	
I certify the following under penalty of perjury, under the laws of the State of California:	
<ol style="list-style-type: none"> I am the Field Technician, or the Field Technician is acting on my behalf as my employee or my agent and I have reviewed the information provided on this Certificate of Acceptance. I am eligible under Division 3 of the Business and Professions Code in the applicable classification to accept responsibility for the system design, construction or installation of features, materials, components, or manufactured devices for the scope of work identified on this Certificate of Acceptance and attest to the declarations in this statement (responsible acceptance person). The information provided on this Certificate of Acceptance substantiates that the construction or installation identified on this Certificate of Acceptance complies with the acceptance requirements indicated in the plans and specifications approved by the enforcement agency, and conforms to the applicable acceptance requirements and procedures specified in Reference Nonresidential Appendix NA7. I have confirmed that the Certificate(s) of Installation for the construction or installation identified on this Certificate of Acceptance has been completed and is posted or made available with the building permit(s) issued for the building. I will ensure that a completed, signed copy of this Certificate of Acceptance shall be posted, or made available with the building permit(s) issued for the building, and made available to the enforcement agency for all applicable inspections. I understand that a signed copy of this Certificate of Acceptance is required to be included with the documentation the builder provides to the building owner at occupancy. 	
Responsible Acceptance Person Name:	Responsible Acceptance Person Signature:
Responsible Acceptance Person Company Name:	Position with Company (Title):
Address:	CSLB License:
City/State/Zip:	Phone:
	Date Signed: