

FEATURES

- Includes fully modulating economizer. (See Form ECO-90 for Economizer Specs).
- Access for motor, blower, and blower drives.
- Adjustable motor sheave.
- Motor with automatic internal thermal protection.
- Modulating option includes fully programmable (factory set) variable frequency drive (VFD) controlled by a differential pressure transducer designed to continuously monitor space pressure.
- Constant Volume option includes a contactor to control on/off operation and communicates with the economizer logic.

DOWN DISCHARGE CENTRIFUGAL POWER EXHAUST AND ECONOMIZER FOR YORK CORE LARGE CABINET UNITS

ZX08-14; ZY07-12; XY07-09; XX08-12; XYA7, ZYA7; ZL08-14

VOLTAGE	External Static (in. W.G)				FLA	Hp	Est. Wt
	0.1	0.2	0.3	0.4			
230V/3Ph	4,400 cfm	4,300 cfm	4,100 cfm	3,900 cfm	3.2	2	248 Lbs. (Includes Economizer)
460V/3Ph					1.6		

PLEASE NOTE:

1. Return air duct, dampers, return air grills are specific for each unit.
2. For proper electrical wire sizing, Provent power exhaust full load amps need to be added to equation.

ProVent P/N

CONSTANT VOLUME	MODULATING
PEDCPRLAC25C 208/230V 3Ph Actuator Only	PEDCPRLAC25M 208/230V 3Ph Actuator Only
PEDCPRLDB25C 208/230V 3Ph Selectable Dry Bulb	PEDCPRLDB25M 208/230V 3Ph Selectable Dry Bulb
PEDCPRLLEN25C 208/230V 3Ph Enthalpy	PEDCPRLLEN25M 208/230V 3Ph Enthalpy
PEDCPRLAC46C 460V 3Ph Actuator Only	PEDCPRLAC46M 460V 3Ph Actuator Only
PEDCPRLDB46C 460V 3Ph Selectable Dry Bulb	PEDCPRLDB46M 460V 3Ph Selectable Dry Bulb
PEDCPRLLEN46C 460V 3Ph Enthalpy	PEDCPRLLEN46M 460V 3Ph Enthalpy

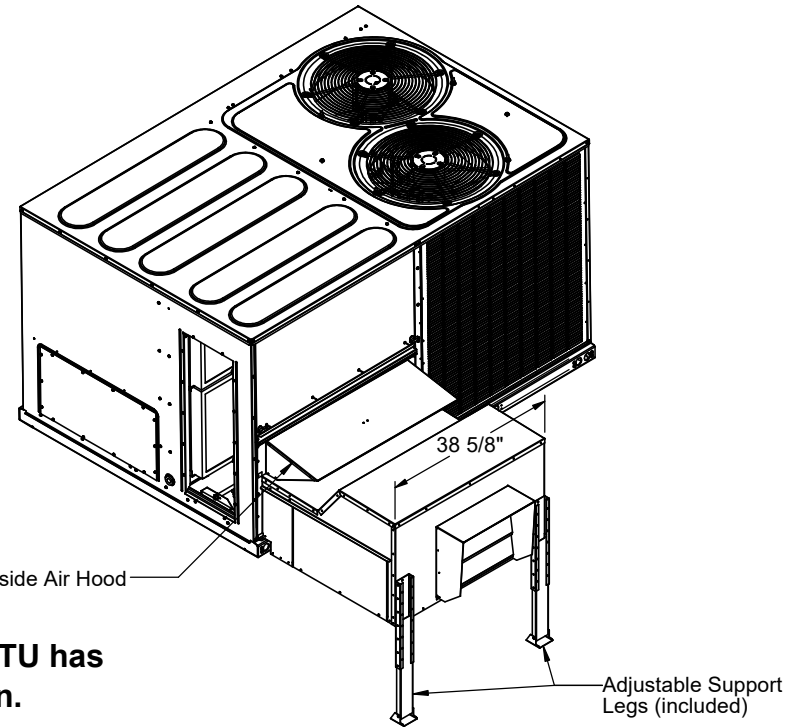
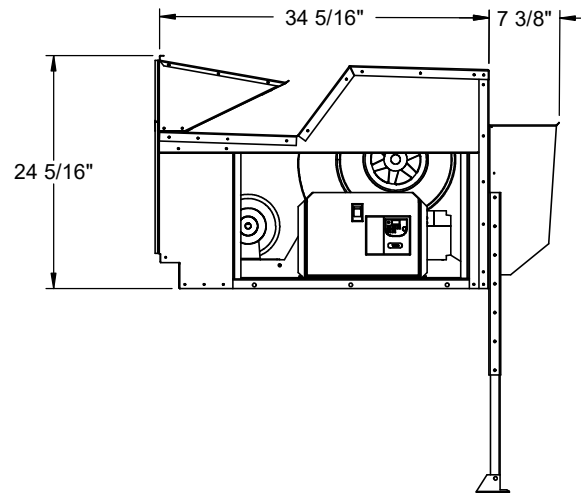

Ruskin Company Model CD-60 is AMCA Certified

Note:
Please contact ProVent if RTU has a hinged filter access option.



3847 WABASH DR.
MIRA LOMA, CA 91752

PHONE (951) 685-1101
FAX (619) 872-9799

SUBMITTED TO: _____
COMPANY: _____
JOB NAME: _____
EQUIPMENT: _____
NOTES: _____

FORM NO:
PE-55

DATE:
4/2/2024

PART NUMBER:
PEDCPRL SERIES

REV:
8

DRAWN BY:
JG

FEATURES

- CA Title 24 Compliant.
 - Direct coupled style actuator standard.
 - Stainless steel damper side seals.
 - AMCA certified CD-60 Airfoil dampers blades.
 - Meets leakage rate as required by ASHRAE 90.1.
 - External linkage system.
 - Mechanically secured outside air intake filter.
 - Metal Filter included:
 - PRS - 25-1/2" x 11" x 7/8" (exact).
 - PRL - 33-1/2" x 10-1/2" x 7/8" (exact).
- FEATURES (When Ordered With Control Options)**
- Fully modulating damper controls with enthalpy, dry bulb and differential temperature sensor options.
 - Selectable economizer changeover temperature set point.
 - Requires part number 2ECO402 for Dual Enthalpy.
 - CO2 controller standard.

Wall or duct mounted CO2 sensor provided as option:

- CO2WM - Wall Mount
- CO2DM - Duct Mount



Ruskin Company Model CD-60 is AMCA Certified

**DOWN DISCHARGE LOW STATIC **
ECONOMIZER WITH BAROMETRIC RELIEF
FOR YORK UNITS:**

**ZX04-14, ZY04-12, ZQ04-06, XY04-09, XX08-12,
XQ04-06, ZXA7, XXA7, XYA7, ZYA7, ZL04-14**

**** FOR RTU'S MANUFACTURED AFTER FEBRUARY 2022**

ECONOMIZER STATIC RESISTANCE TABLE

UNIT	CFM	RETURN AIR STATIC LOSS	
		ECODPR*** ESP (OLD)	ECODPR***2 ESP (NEW)
PRS	1200	0.24	0.06
	1600	0.52	0.12
	2000	0.81	0.17
	2400	1.10	0.22
	3000	1.54	0.33
PRL	2400	0.21	0.08
	3000	0.35	0.18
	3400	0.47	0.23
	4000	0.66	0.30
	5200	1.04	0.41

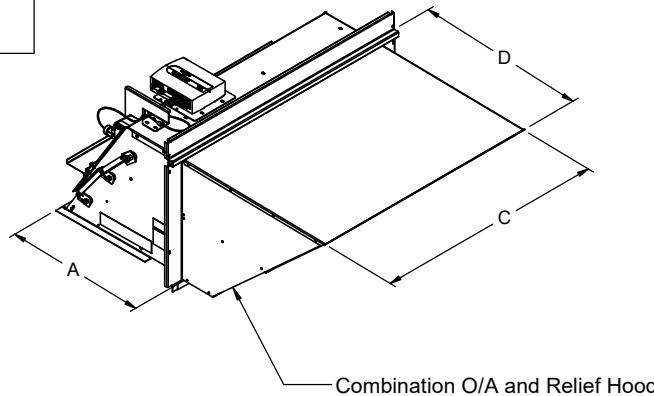

York Unit	ProVent P/N	"A"	"B"	"C"	"D"	Weight
ZX 04-07 ZY 04-06 ZQ 04-06 XY 04-06 XQ 04-06 ZXA7 XXA7 ZL 04-06	ECODPRSD2 (Fully Modulating Dry Bulb) ECODPRSEN2 (Fully Modulating Enthalpy) ECODPRSAC2 (Actuator Only)	17-3/16"	18-3/8"	33-1/4"	17-3/8"	81 Lbs.
ZX 08-14 ZY 07-12 XX 08-12 XY 07-09 XYA7 ZYA7 ZL 08-14	ECODPRLDB2 (Fully Modulating Dry Bulb) ECODPRLN2 (Fully Modulating Enthalpy) ECODPRLAC2 (Actuator Only)	19-3/4"	23-7/16"	40-3/4"	22"	94 Lbs.

CORE Large Cabinet Shown

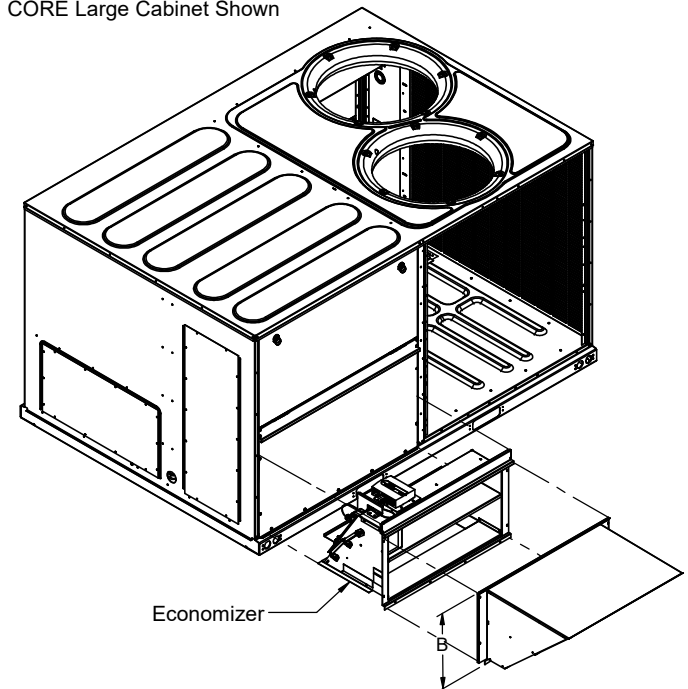

Note:
Please add an H to the end of the part number if RTU has a hinged filter access option.



3847 WABASH DRIVE
MIRA LOMA, CA 91725

PHONE (951) 685-1101
FAX (619) 872-9799

SUBMITTED TO: _____
COMPANY: _____
JOB NAME: _____
EQUIPMENT: _____
NOTES: _____

FORM NO:
ECO-79

DATE:
3/18/2024

PART NUMBER:
ECODPR_2 Series

REV: 2
DRAWN BY: CNG